

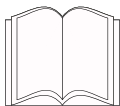

| | | | |
|-----------|----------------------------|--------------|----------------------------------|
| de | Montageanleitung | sr | Uputstva za montažu |
| en | Installation instructions | et | Paigaldusjuhised |
| fr | Notice d'installation | lt | Įrengimo instrukcijos |
| nl | Installatie-instructies | lv | Uzstādīšanas instrukcijas |
| it | Istruzioni d'installazione | sk | Pokyny na inštaláciu |
| el | Οδηγίες εγκατάστασης | sq | Udhëzimet e instalimit |
| es | Instrucciones de montaje | fa | دستورالعمل نصب |
| pt | Instruções de instalação | ar | تعليمات التركيب |
| sv | Installationsanvisningar | ko | 설치 설명서 |
| no | Installasjonsveiledning | zh | 安装说明 |
| fi | Asennusohjeet | uk | Інструкція з монтажу |
| da | Installationsvejledning | ro | Instrucțiuni de instalare |
| tr | Kurulum talimatları | bg | Инструкции за монтаж |
| ru | Инструкция по установке | ja | 設置説明書 |
| cs | Pokyny k instalaci | he | הוראות התקנה |
| pl | Instrukcje montażu | id | Petunjuk pemasangan |
| hu | Telepítési útmutató | kk | Орнату нұсқаулықтар |
| hr | Upute za instalaciju | zh-hk | 安裝說明 |
| mk | Упатства за инсталирање | zh-tw | 安裝說明 |
| sl | Navodila za montažo | uz | O'rnatish bo'yicha yo'riqnomalar |





| | | | |
|-----------|---|--------------|---|
| de | über den Kundendienst erhältlich | sr | može se dobiti preko korisničkog servisa |
| en | Available from our after-sales service | et | saadaval hooldekeskuse kaudu |
| fr | disponible via le service après-vente | lt | galima įsigyti klientų aptarnavimo tarnyboje |
| nl | bij de servicedienst verkrijgbaar | lv | var saņemt klientu apkalpošanas dienestā |
| it | disponibile presso il servizio di assistenza clienti | sk | dostupné prostredníctvom zákazníckeho servisu |
| el | διαθέσιμο από την υπηρεσία εξυπηρέτησης πελατών | sq | marrja e mundshme përmes shërbimit të klientit |
| es | disponible a través del Servicio de Atención al Cliente | fa | در مرکز خدمات مشتریان موجود است |
| pt | pode ser adquirido nos nossos Serviços Técnicos | ar | يمكن الحصول عليها من خدمة العملاء |
| sv | går att beställa via service | ko | 고객 서비스센터를 통해 구입 가능 |
| no | fås hos kundeservice | zh | 可向客户服务索取 |
| fi | saatavissa huoltopalvelusta | uk | Через сервісну службу |
| da | Fås hos kundeservice | ro | se pot obține de la serviciul de asistență pentru clienți |
| tr | müşteri hizmetlerinden temin edilebilir | bg | предоставя се от службата за обслужване на клиенти |
| ru | можно приобрести через сервисную службу | ja | カスタマーサービスを通じて入手可能 |
| cs | k dostání v zákaznickém servisu | he | זמין דרך שירות הלקוחות |
| pl | do nabycia w punkcie serwisowym | id | Tersedia di Layanan Pelanggan |
| hu | a vevőszolgáltatón keresztül kapható | kk | сервистік қызмет арқылы алуға болады |
| hr | može se kupiti kod servisne službe | zh-hk | 可向售後服務站索取 |
| mk | достапно преку сервисната служба | zh-tw | 可向客戶服務單位索取 |
| sl | na voljo prek pooblaščenega servisa | uz | otishdan keyingi xizmat orqali olish mumkin |

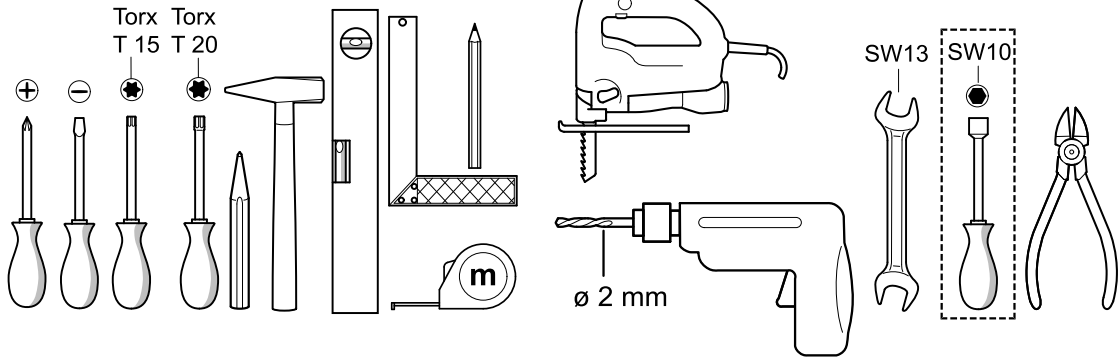
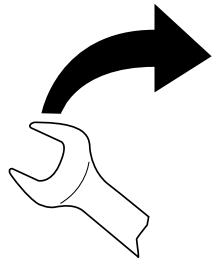
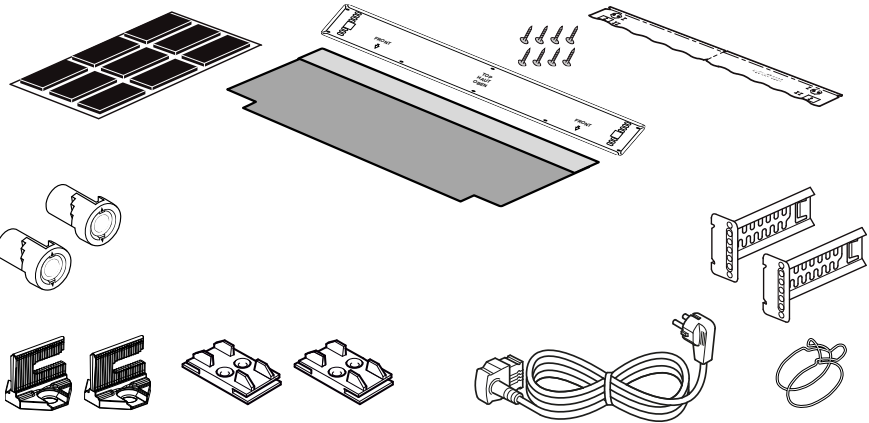
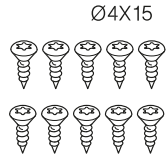
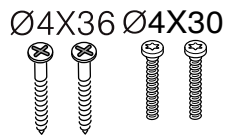

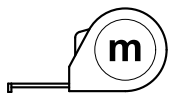
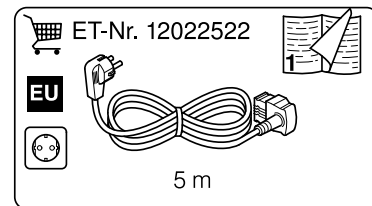
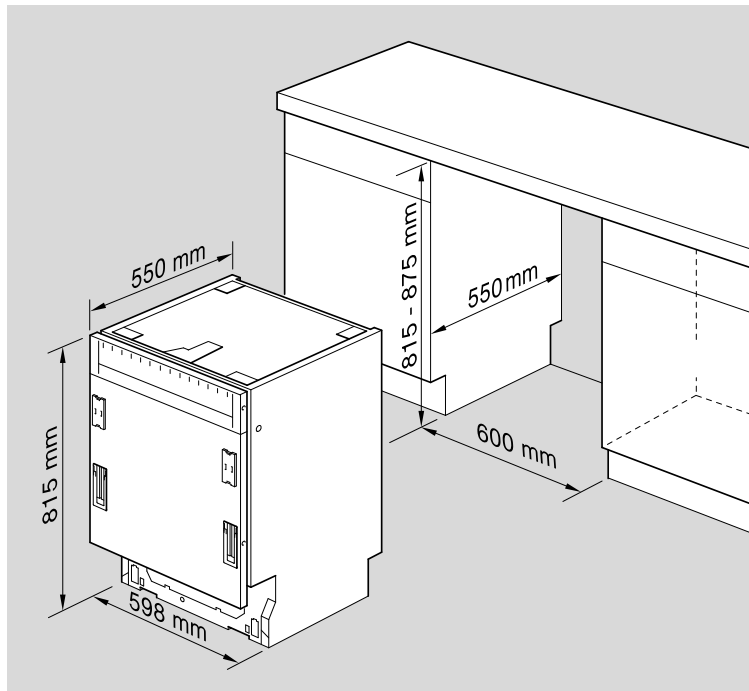
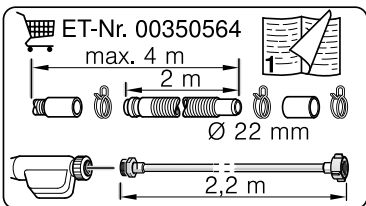
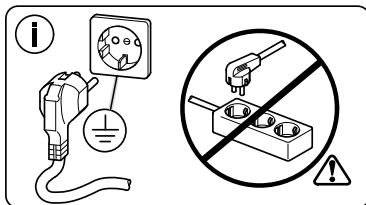
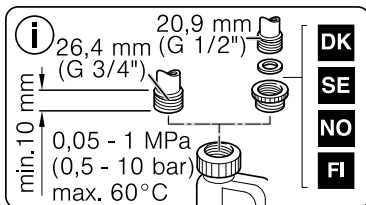
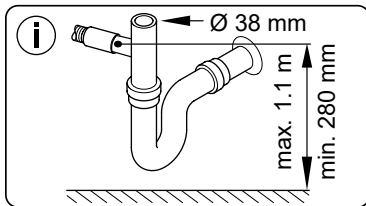

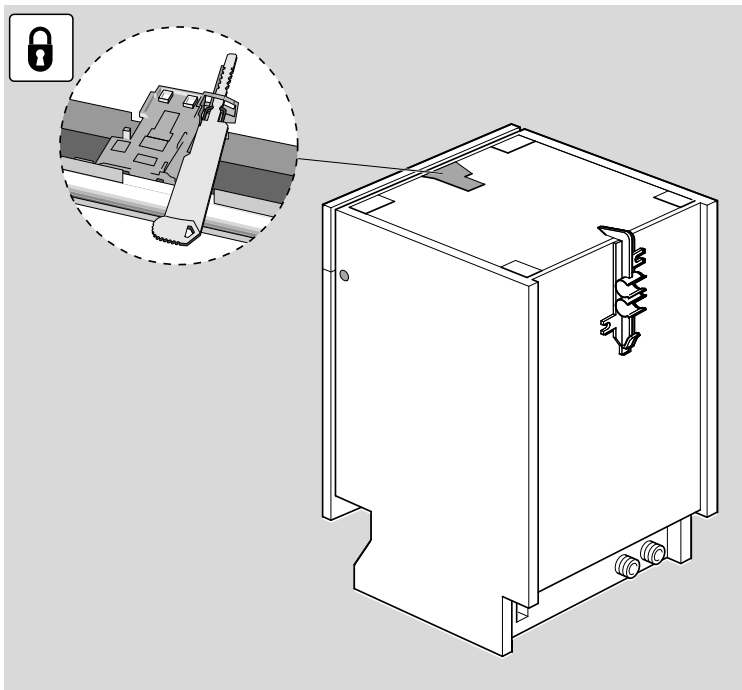
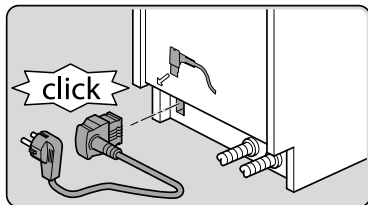
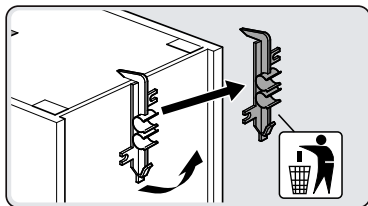

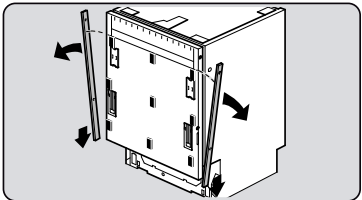
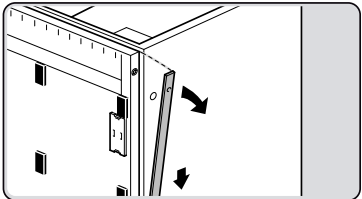
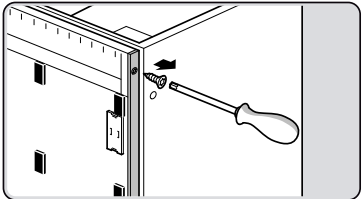
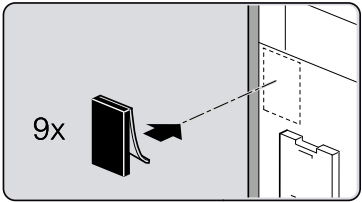
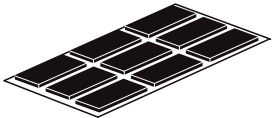

Torx
T 15

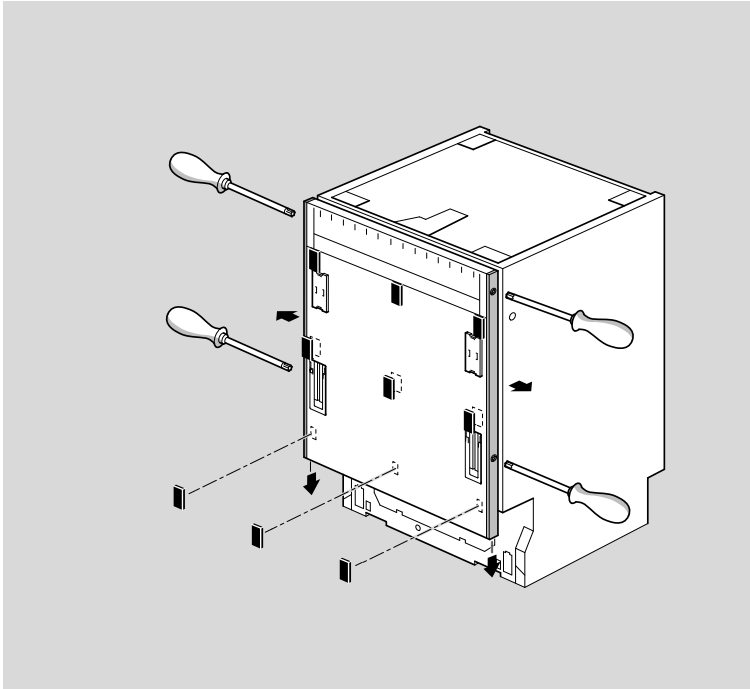
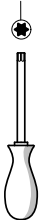

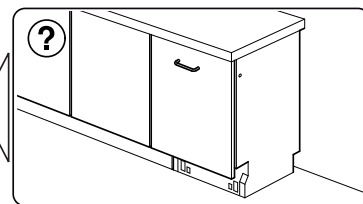
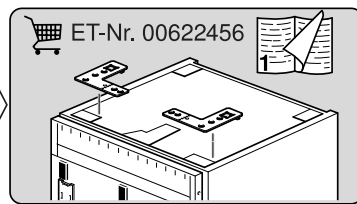
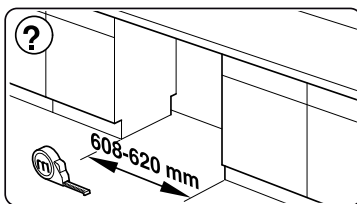
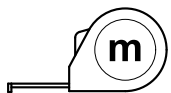
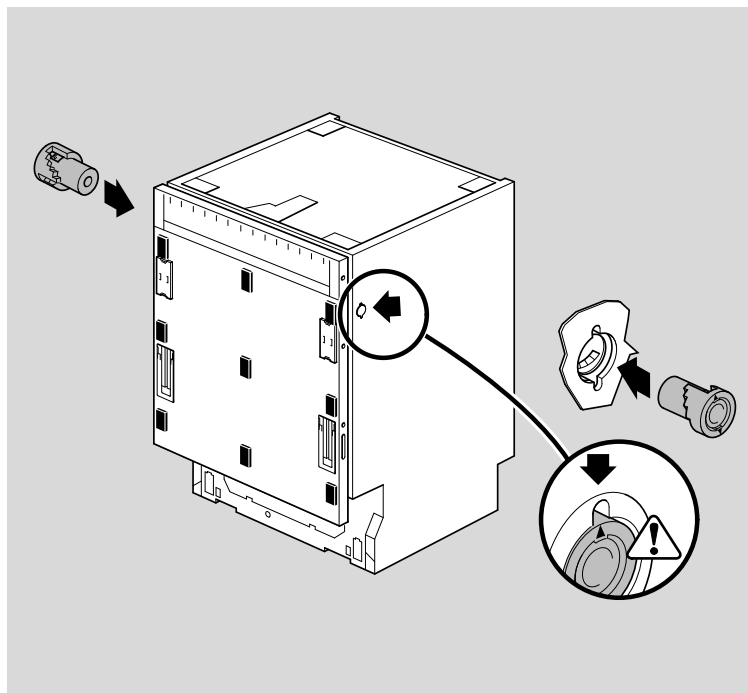
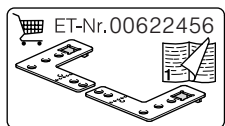
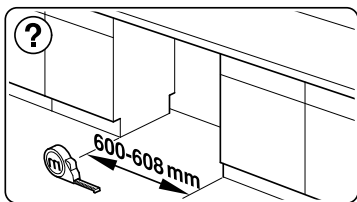

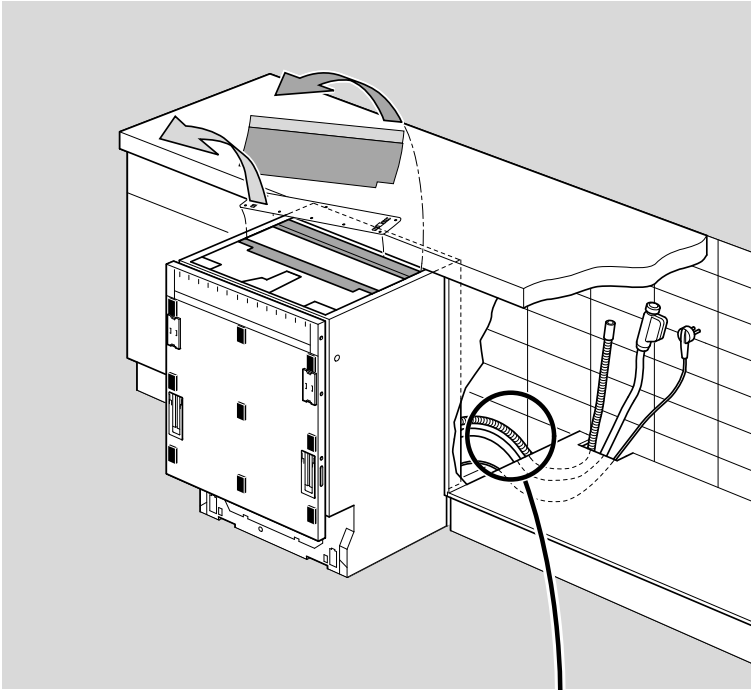
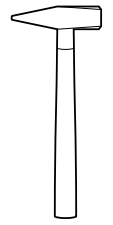
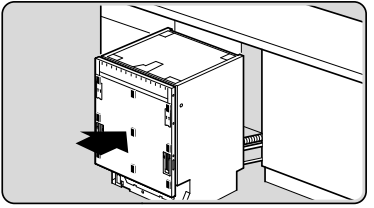
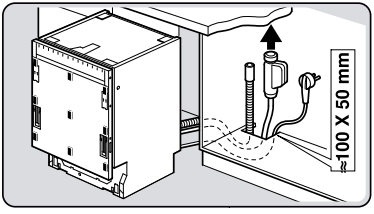
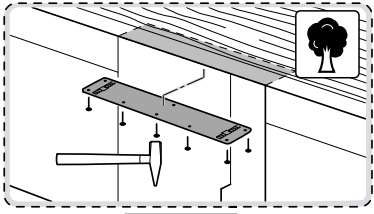
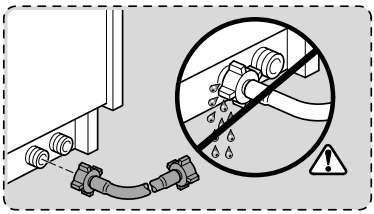
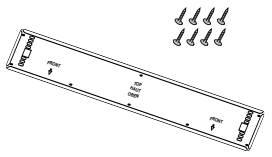

nicht einklemmen
do not pinch
ne pas coincer
No doblar

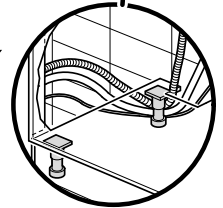

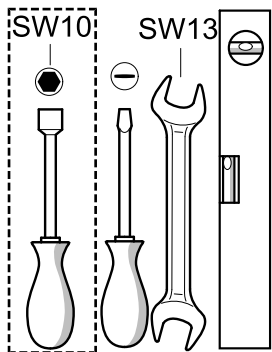
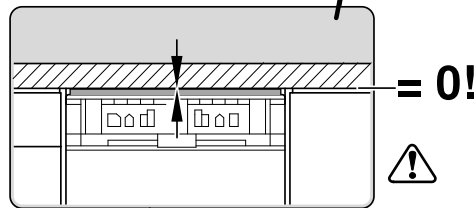
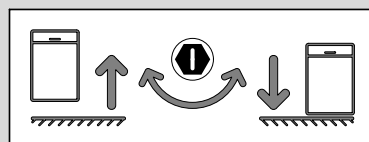
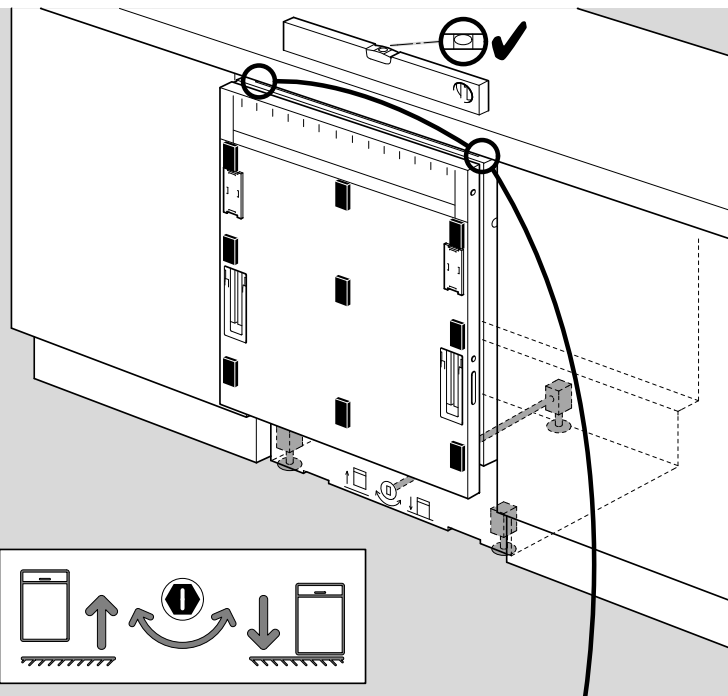
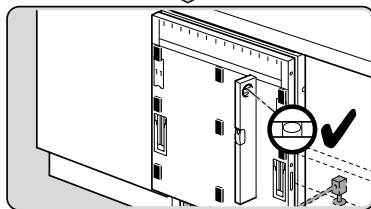
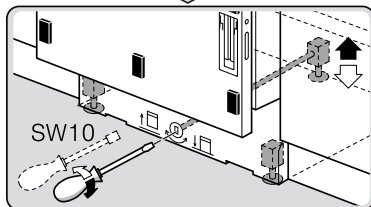
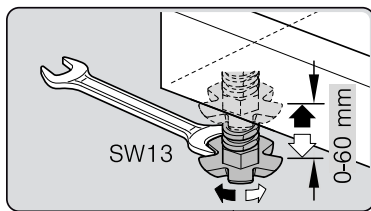

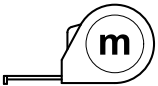
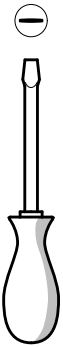
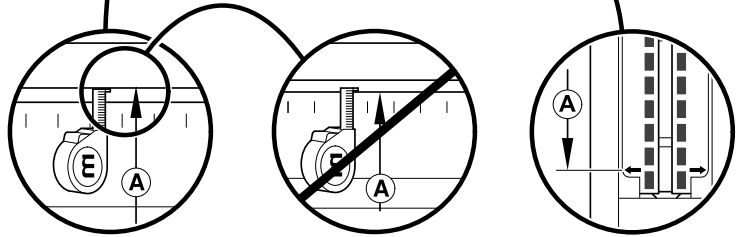
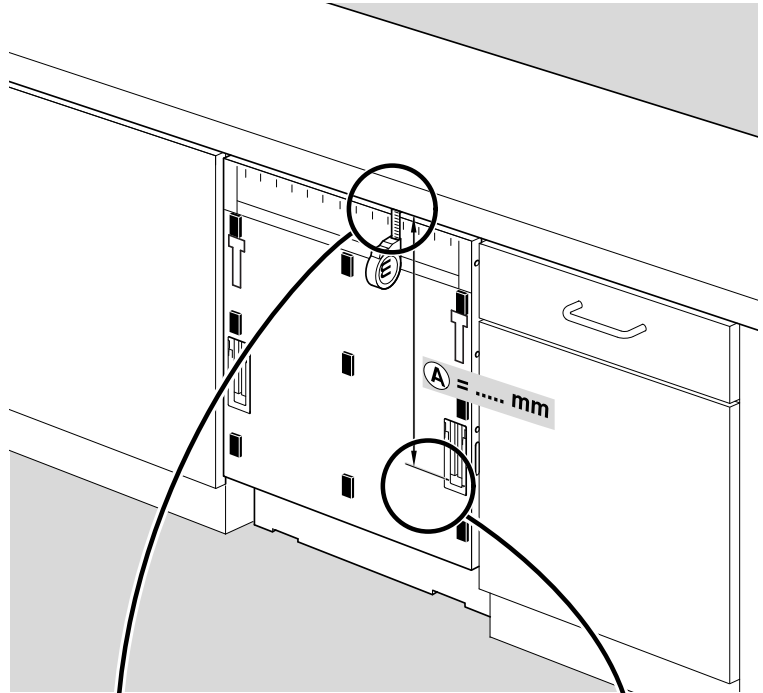
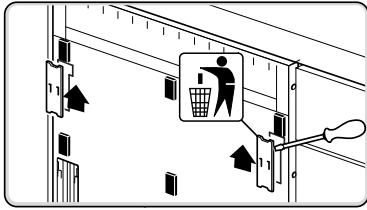

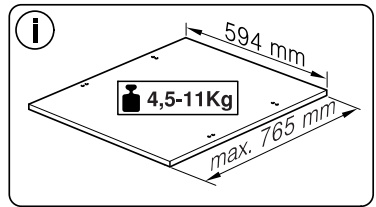
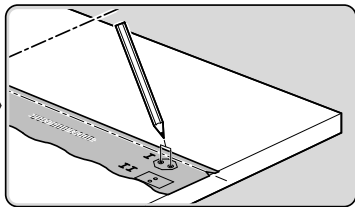
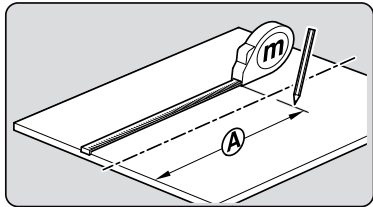
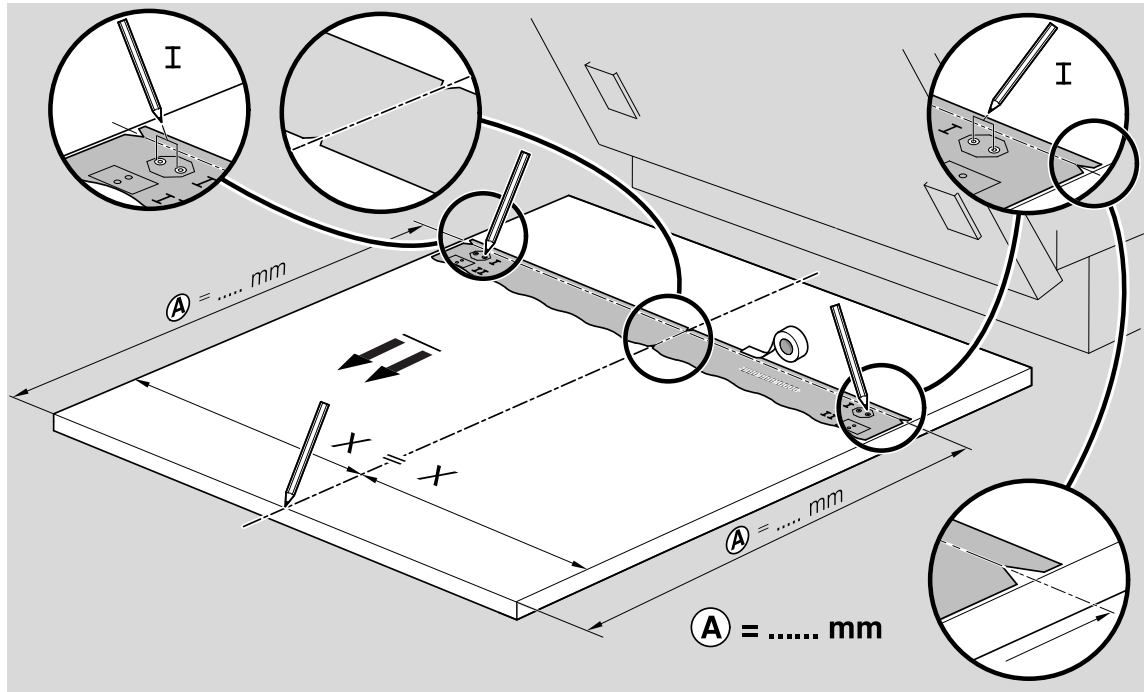
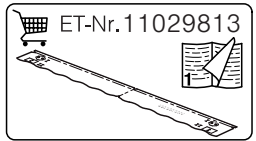

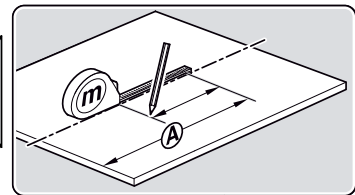
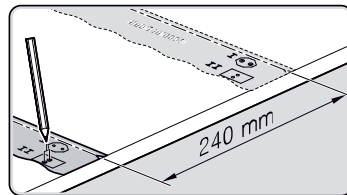
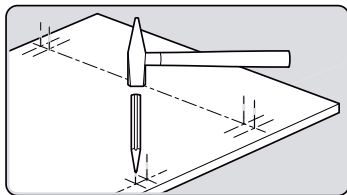
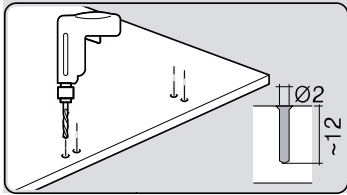
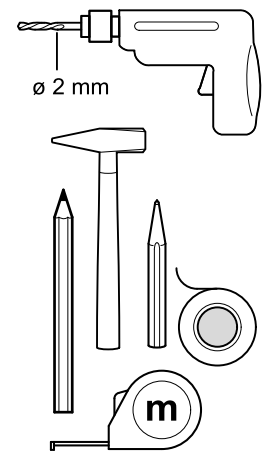
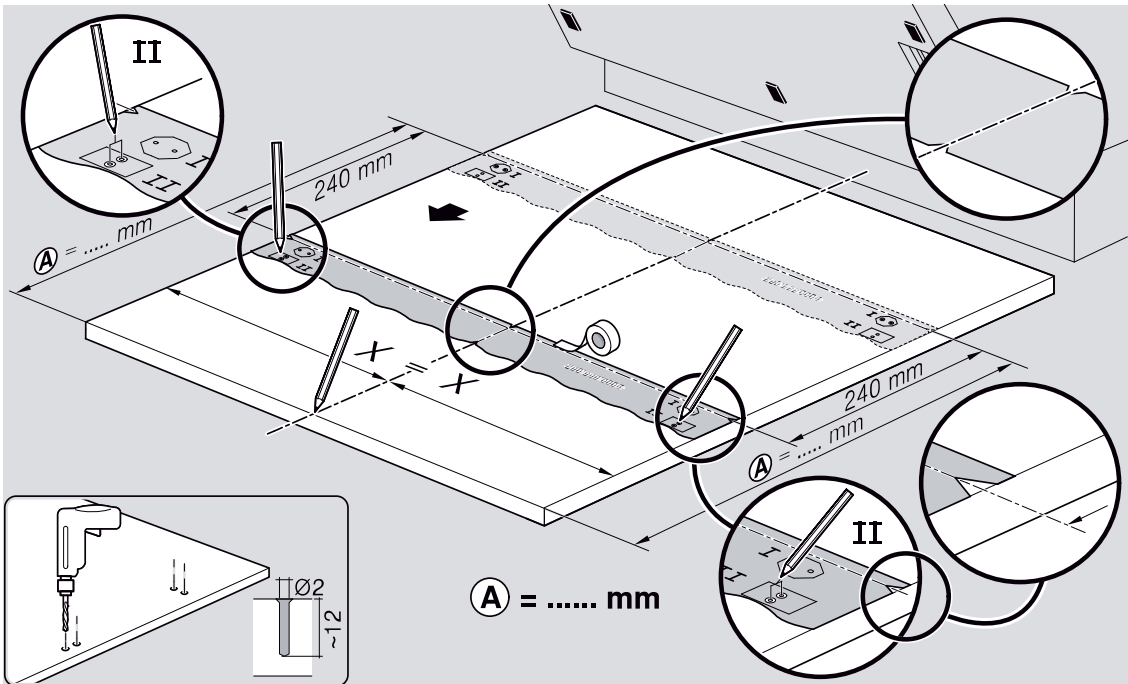
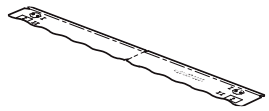

Ø4X15



Torx
T 20



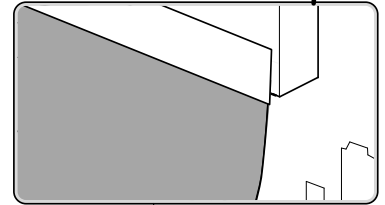
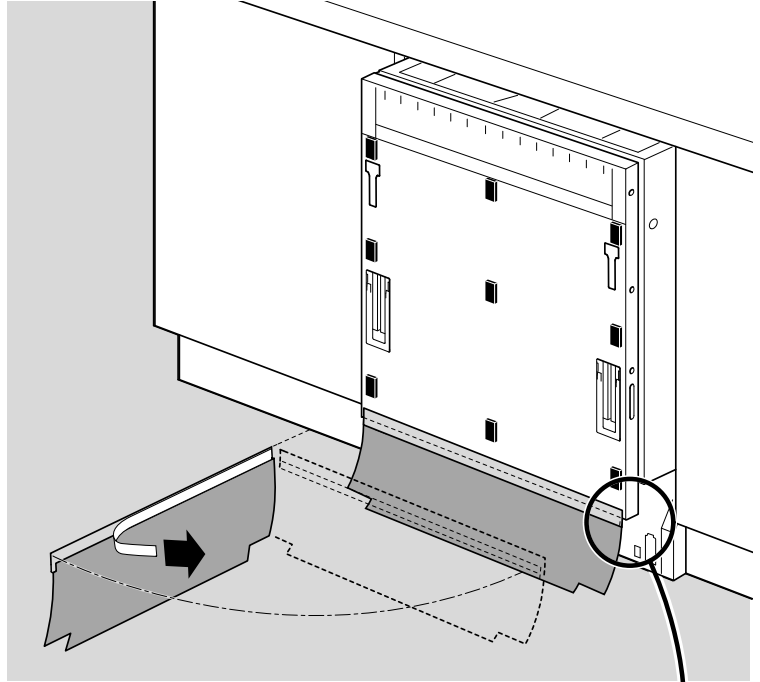
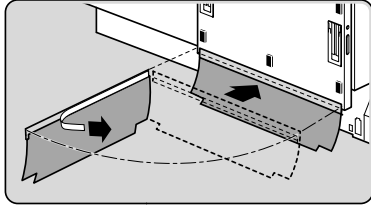
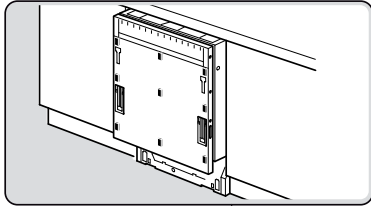
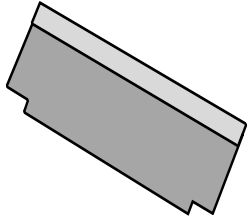

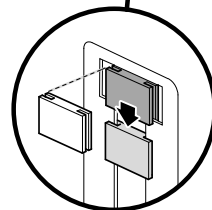
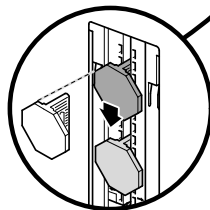
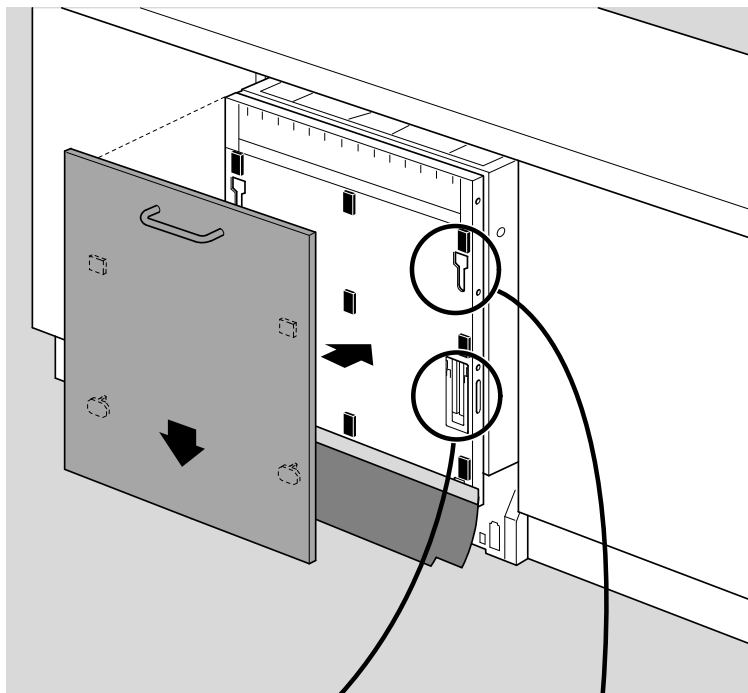
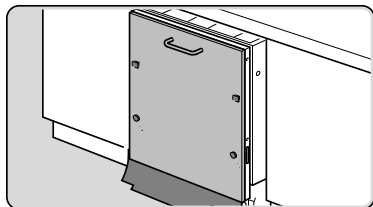
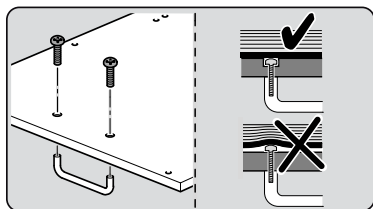

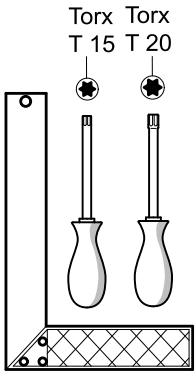
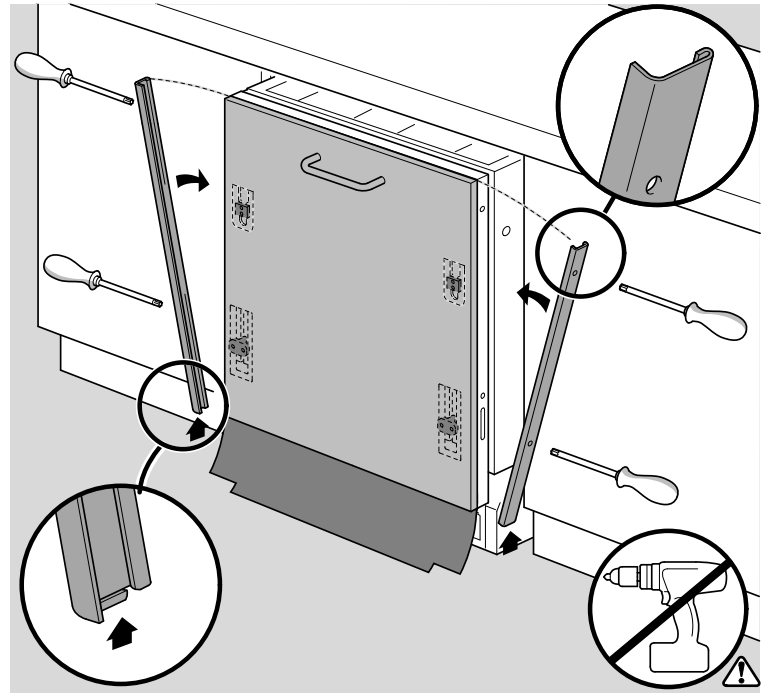
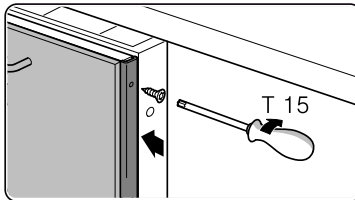
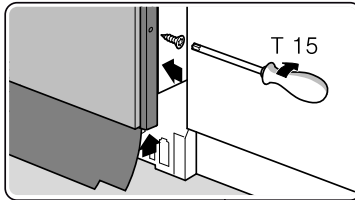
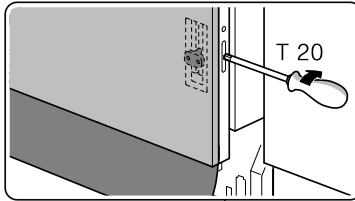
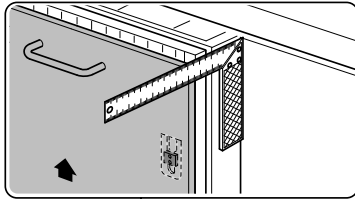

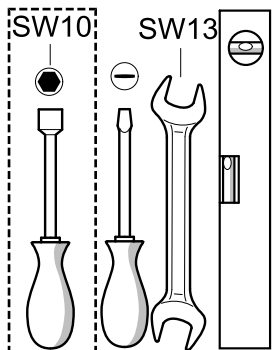
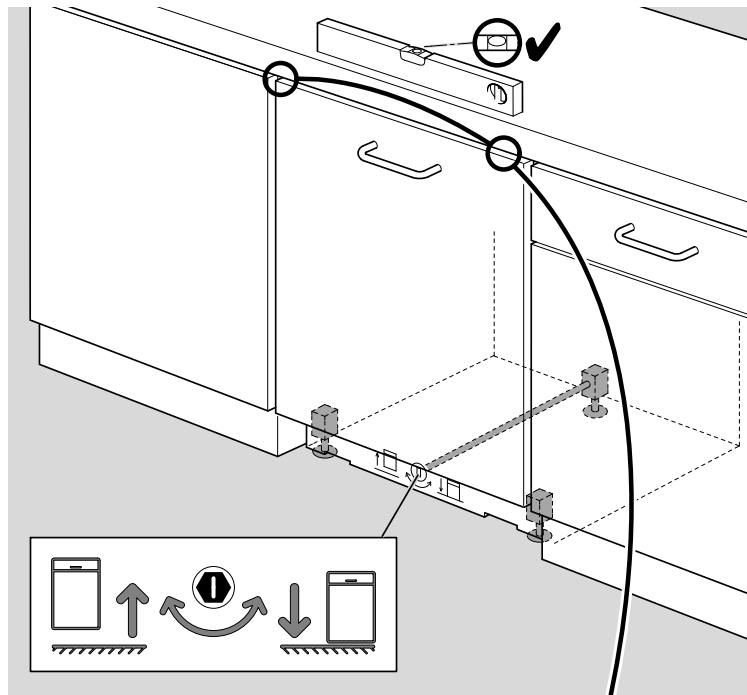
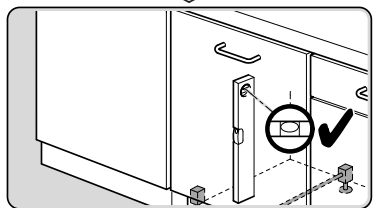
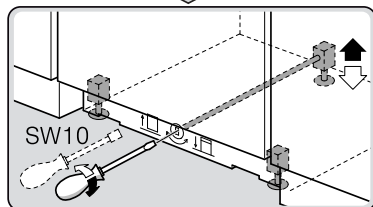
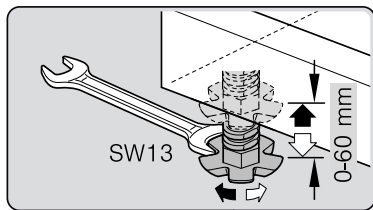

verspannen
brace
calar verticalement
Enrasar

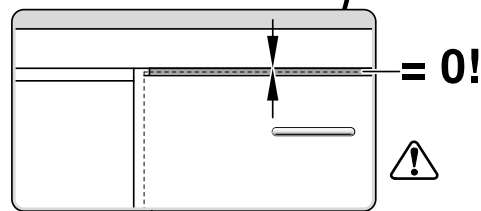

Ø4X30



Torx
T 20

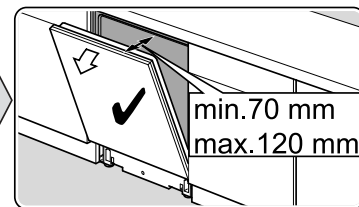
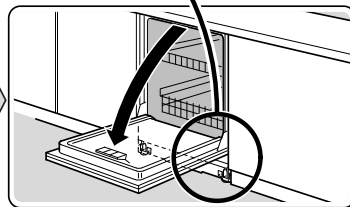
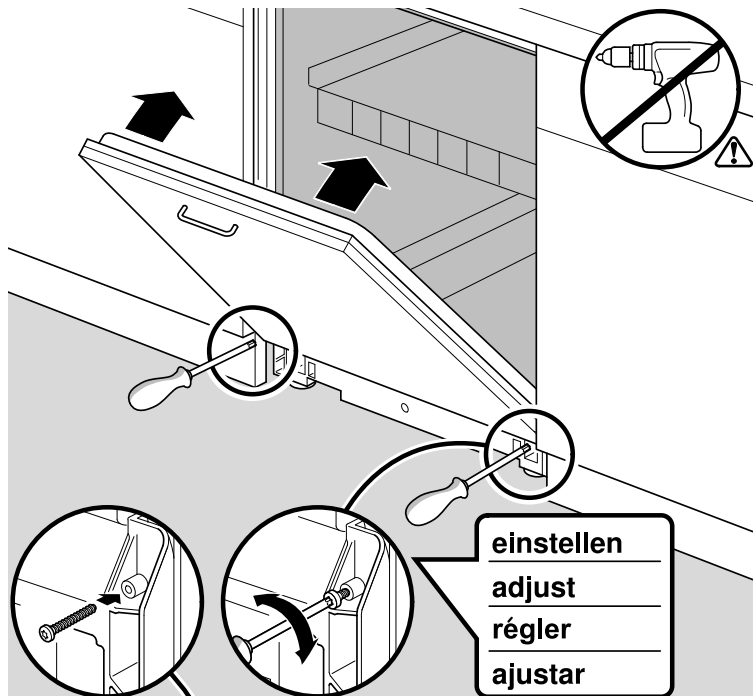
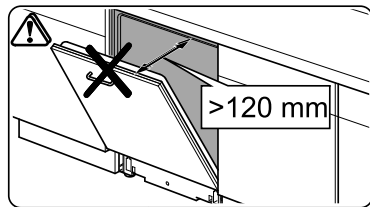
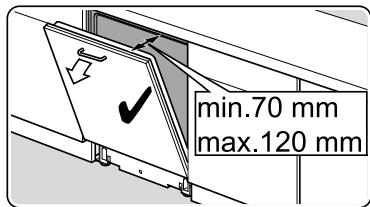

Ø4X36

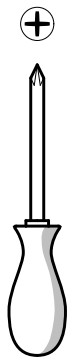
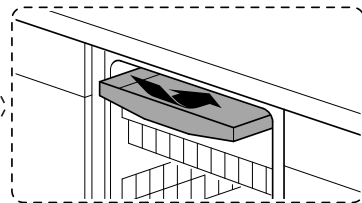
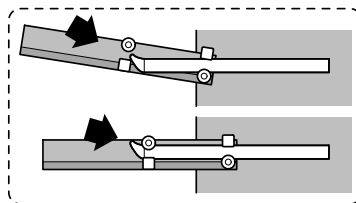
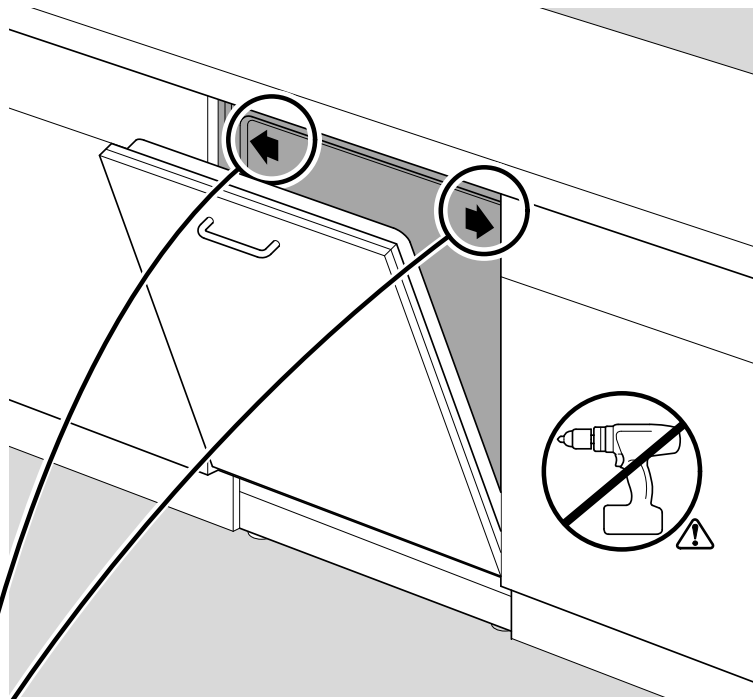
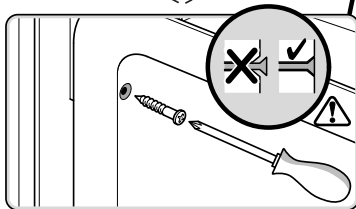
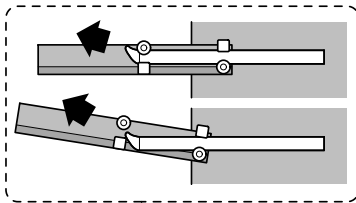
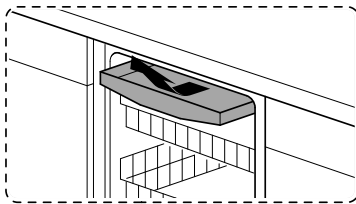
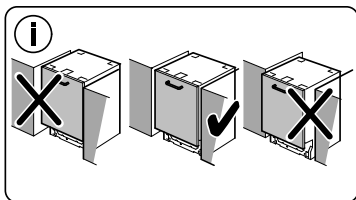
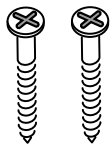

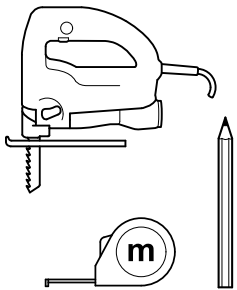
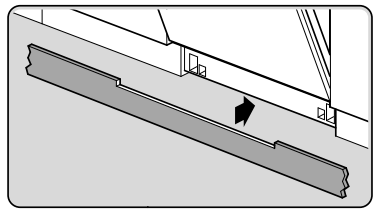
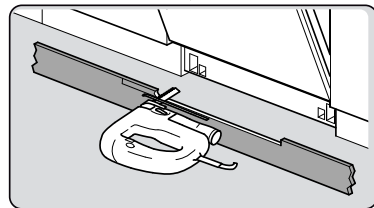
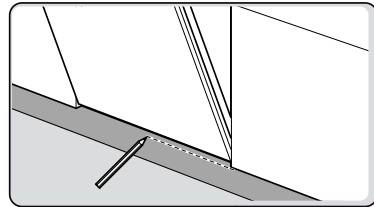
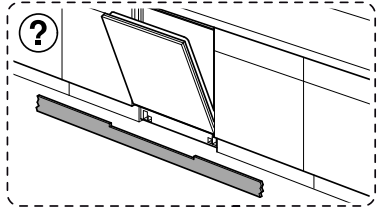
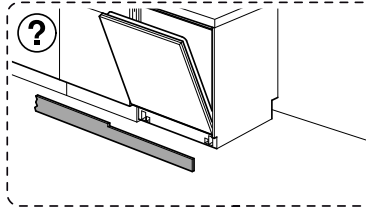
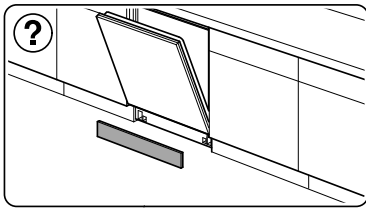

Ø4X15

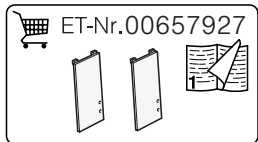
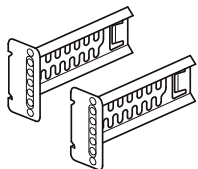

Torx
T 20

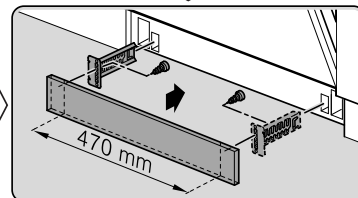
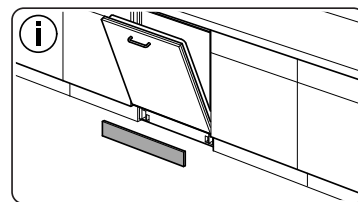
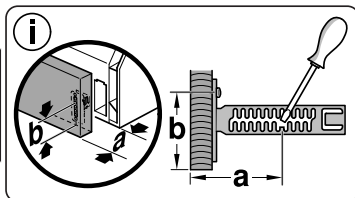
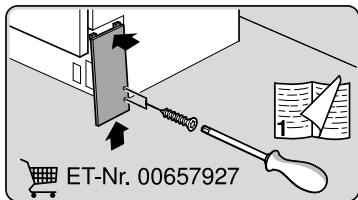
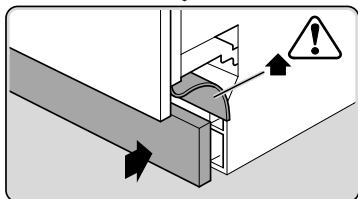
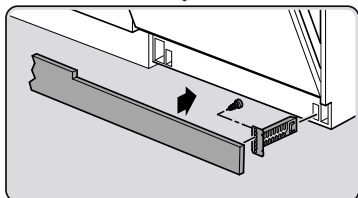
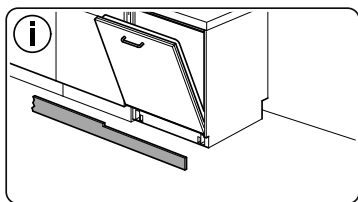
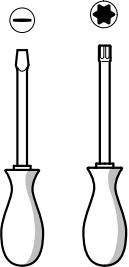

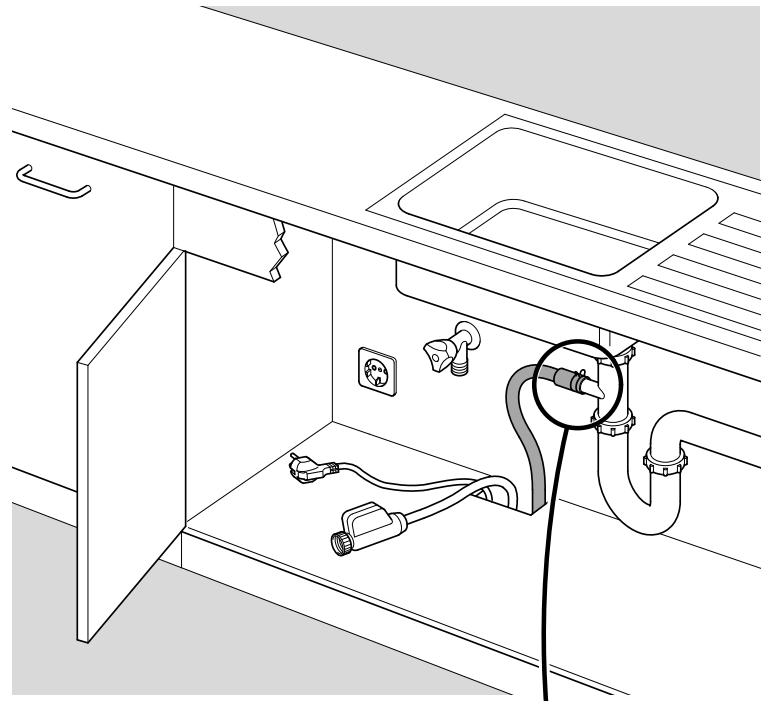
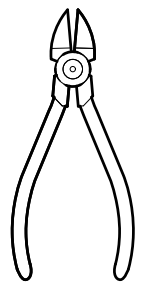
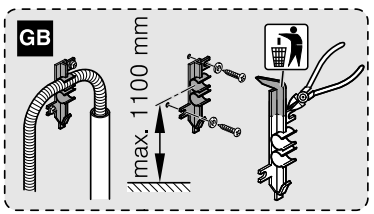
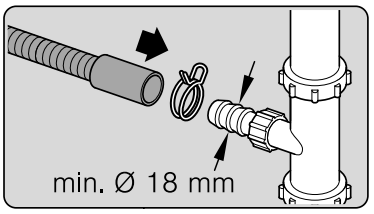
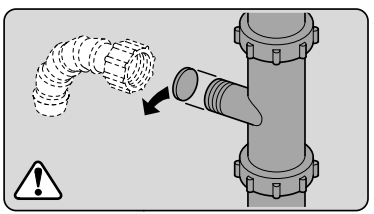

Dichtheit prüfen
Check for leaks
Verifiez l'étanchéité
Verificar la estanqueidad

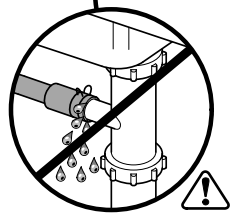

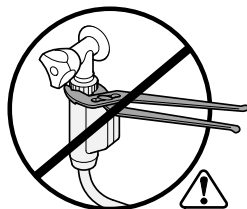
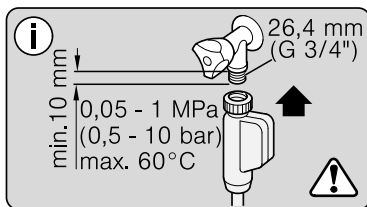

max. 10 Nm

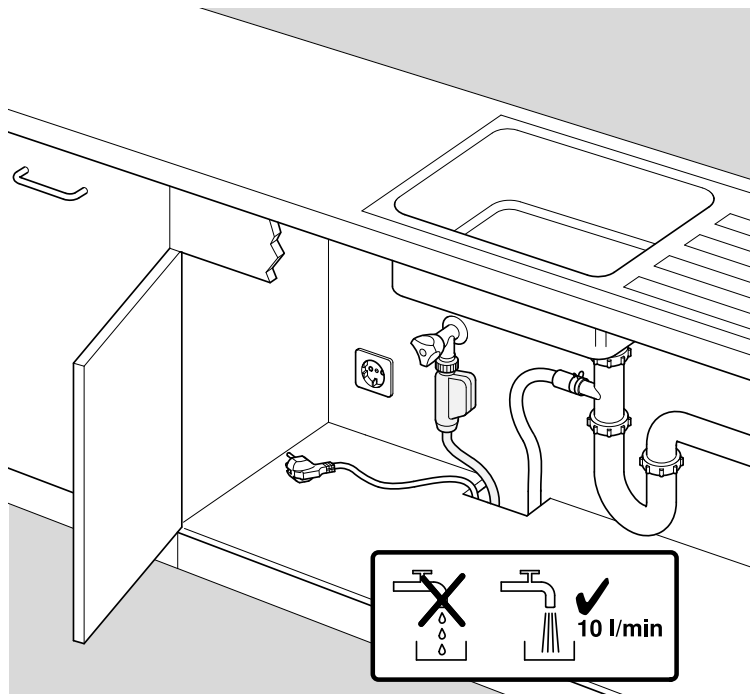

Dichtheit prüfen
Check for leaks
Verifiez l'étanchéité
Verificar la estanqueidad



